



Investigating the control of manganese sulphide precipitation

by Y.-L. Chiang*, J. Nathoo* and A.E. Lewis*

Paper written on project work carried out in partial fulfilment of BSc (Eng) (Chemical)

Synopsis

The generation and control of manganese sulphide particle size distribution using various mixing configurations were investigated.

Specifically, this paper discusses how varying mixing intensities on a macro and micro scale affect the resultant manganese sulphide particle size distribution (PSD) at a constant concentration. The mixing variations were achieved using various Y- and T-mixers as premixing devices into a jacketed, agitated vessel. The reagents used to generate the seeds were aqueous manganese sulphate and sodium sulphide solutions.

The results showed that the absence of micromixing resulted in very poor control of the particle size distribution, the particle size and the number of particles produced. This was due to the fact that the macromixing time is much greater than the corresponding precipitation time, resulting in different mixing regions existing within the reactor.

From the micromixing experiments, the T-mixer was found to be the most effective mixing device at lower concentrations due to the T-mixer providing a faster mixing time than the other mixing configurations, thereby effectively localizing the supersaturation and hence controlling the precipitation.

The results obtained from the direct addition without the extension pipe (i.e. short mixing time) indicated a general increase in mean particle size and decrease in total particle number at reagent concentration of $0.007 \text{ mol.dm}^{-3}$ as compared to the corresponding micromixing experiments. The phenomenon may be due to incomplete crystallization at the immediate exit of the mixing device. Further experiments need to be conducted before any conclusions can be drawn about the precipitation mechanisms.

Introduction

The electrolysis of manganese sulphate (MnSO_4) is the final unit operation in the manganese ore refining process. The industrial feed to the electrowinning unit contains predominantly MnSO_4 and ammonium sulphate with trace amounts of metal impurities in the form of nickel and cobalt sulphates. The amount of nickel and cobalt impurities in the feed directly affects the current efficiency and purity of manganese during the electroplating process (Bryson, 1990). A recent paper written by Lewis and van Hille (2005) indicated that the main

advantages of using sulphides rather than hydroxides during precipitation are the high degree of metal removal at a relatively low pH and sparingly soluble characteristics of the sulphide precipitates. The sulphides also form stable solids, which have good dewatering characteristics.

The use of seeds during the precipitation stage creates an environment for heterogeneous nucleation. Since the level of supersaturation is the main driving force in any crystallization process (Myerson, 2002), the introduction of a foreign solid substance lowers the free energy barrier of the reacting system; hence, nucleation will occur at a lower supersaturation than for homogeneous systems.

The chemical reaction kinetics associated with most precipitation processes are often very fast (Garside and Tavaré, 1985). Thus, in many precipitation processes, the mixing is very important and contributes significantly to the degree and distribution of supersaturation throughout the reactor. Consequently, this affects the particle size distribution as the hydrodynamics in an agitated vessel differs significantly based on the location in the vessel (Torbacke *et al.*, 2001).

In an agitated tank, there exist regions of different mixing intensities due to the non-symmetry of the turbulent velocity field necessary for bulk convective mixing for solid-liquid phase systems (Hinze, 1975). The mixing within the agitated vessel is divided into two regions (1) the mesomixing (segregated zone) around the feed point within the reactor and (2) the macromixing (well-mixed bulk zones), which comprise the rest of the reactor vessel.

* *Crystallisation and Precipitation Research Unit, Chemical Engineering Department, University of Cape Town, Rondebosch, South Africa.*

© *The Southern African Institute of Mining and Metallurgy, 2007. SA ISSN 0038-223X/3.00 + 0.00. Paper received Mar. 2006; revised paper received Apr. 2007.*

Investigating the control of manganese sulphide precipitation

Work was previously done by Pohorecki and Baldyga (1979, 1983 and 1988) within the context of fast reacting precipitation systems to develop a model to characterize the level of micromixing intensities on precipitation and consequently the particle size distribution (PSD) in an agitated vessel. However, the results seemed not to be successful since the model excluded the interaction between micro-and macromixing and considered only the former within the process.

In order to achieve a narrow particle size distribution, the supersaturation characteristics must be constant throughout the solution reaction volume. According to Nagata (1975), mixing characteristics of homogeneous solutions in a stirred vessel indicated the generation of vortices where lack of intimate mixing are found. Variations in supersaturation may thus lead not only to a significant size distribution, but also variations in morphology as well. To generate constant supersaturation and intimate micromixing of reagents, it is proposed that Y- and T-mixers be utilized for the generation of narrow particle size distributions (see Figure 1). The micromixing of reagents can also be done prior to the addition to the reactor. In this method the global supersaturation will be approximately equal to the local supersaturation (the volume of the mixing medium is small and mixing intensity increased) and control over the precipitation can be better anticipated. The mixing of reagents in these mixers are much more turbulent and therefore the particle size and distribution is greatly affected (Gradl *et al.*, 2005).

In an experiment conducted by Blandin *et al.* (2000) the precipitation of salicylic acid (also sparingly soluble) in a batch stirred vessel and a T-mixer was studied. They found that crystals at the T-mixer exit were much smaller than the samples from the agitation vessel. According to Blandin, it is evident that crystallization is not complete at the T-mixer exit.

In order to make valid quantitative comparisons across different particle size distributions, the coefficient of variance (or normalized distribution variance) are determined. From a mathematical point of view, the total particle number for a particular distribution is also regarded as the zeroth moment of the distribution. Since the total number of particles varies with different mixing configurations, direct determination of distribution variance was not sufficient for comparing the distribution spread from the various experiments.

The coefficient of variance (CV), as taken from Randolph and Larson (1971), was used to generate a normalized distribution width, which enabled direct comparison across different PSDs. The equation is shown below:

$$CV = \left(\frac{m_2}{m_1^2} - 1 \right)^{0.5}$$

The CV is a function of both the first and second moment (m_1 and m_2) of the distribution. The first moment of the distribution gives the total length of the particles in the system; while the second moment gives the total area of the particles. The moments can be determined by using the simple integral expression:

$$m_j = \int_0^{\infty} L^j n(L) dL$$

This paper presents some preliminary work on the application of Y and T micromixing devices and their effects on the resultant particle size distribution at a constant reagent concentration of 0.007 M. These results are then compared with a base case scenario where particle size distributions were generated by macromixing only.

Materials and methods

Reactor configuration

A baffled 1.6 litre jacketed glass agitation vessel was used in combination with a stainless steel 6-flat-bladed rushton turbine. Two 250 ml glass jacketed reagent containers were also used to ensure isothermal operation during the entire experimental period. A temperature bath was used to maintain the temperature of the utility water through all vessel jackets at 40°C (See Figure 2). Two Y-mixers with different mixing angles were used and a T-mixer was utilized as premixing devices to promote micromixing in separate experiments.

The just-suspended impeller speed for this project was determined by observation and confirmed by using the N_{js} equation (Armenante *et al.*, 2006) shown below:

$$N_{js} = S \cdot v^{0.1} \left[\frac{g \cdot (\rho_s - \rho_L)}{\rho_L} \right]^{0.45} \frac{d_p^{0.2}}{D^{0.85}} X^{0.13}$$

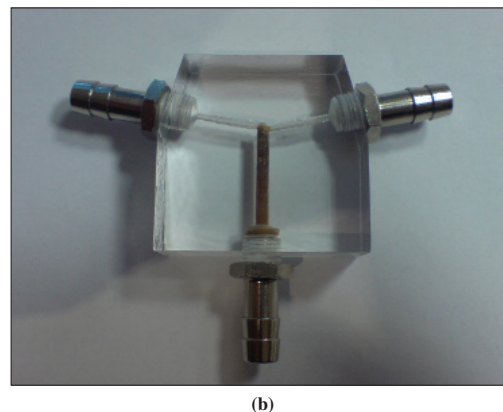
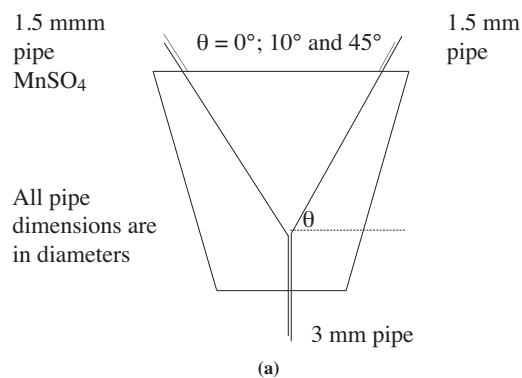

Figure 1—(a) Reagent feed configuration in the presence of micromixing; (b) The actual micromixing device

Investigating the control of manganese sulphide precipitation

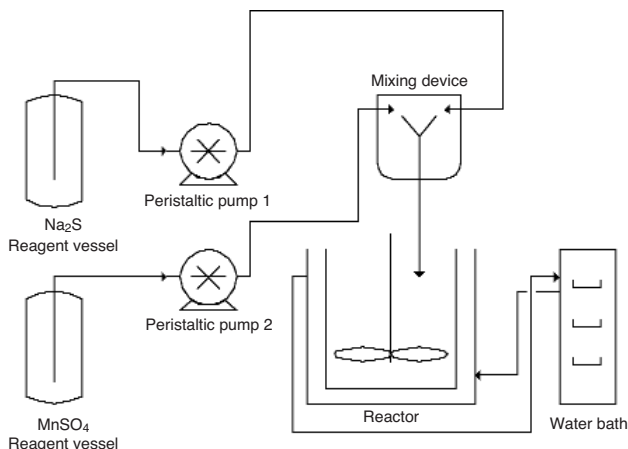

Figure 2—Schematic representation of the experimental set-up

The N_{fs} value for this experimental system was found to be approximately 270 rpm.

Reagent preparation and sampling

The reagents used were manganese sulphate ($MnSO_4$) and sodium sulphide (Na_2S). Deionized water was used as a diluent to make up standard solutions of $MnSO_4$ and Na_2S . Initially, three different reagent concentrations of (0.01 M, 0.007 M and 0.001 M) were prepared in order to determine the most suitable concentration for the measurements of particle size distributions via the electrozone sensing technique using a Beckman™ Coulter Multisizer 3.

It was found that a concentration of 0.007 M for both reagents was ideal for reactor sampling at 10-minute intervals.

Experimental design

Table I shows a list of all the experiments conducted along with their corresponding objective, method and conditions.

The samples were taken via a glass pipette and particle size distributions were analysed immediately.

Results and discussion

See Figures 3–12

With respect to the narrowness of the particle size distribution, the control of the precipitation of MnS without micromixing was very poor compared to the results obtained

for experiments with micromixing under similar conditions. From Figure 3 it can be seen that the number density is the lowest and the coefficient of variance is the greatest for the scenario without micromixing. Therefore, the width of the particle size distribution is greater than that for the various micromixing experiments. This can be attributed to the large variation in the distribution of supersaturation, creating regions of varying degrees of supersaturation, which exist throughout the reactor once the reagents were added and mixed.

The supersaturation will be expected to be the greatest at the points where the concentration of the two reagents are the highest (closer to the impeller) within the reaction vessel and conversely the lowest where the concentration of the reagents is the least (i.e. reactor walls and far away from impeller). This results in a large spread of particle sizes, with smaller particles forming at the higher concentration zones and the larger particles at the lower concentration zones. For the scenario without micromixing, the particle sizes were found to be the greatest (Figure 5) with the least number of particles (Figure 6) after a residence time of 40 minutes within the reactor. This illustrates the inability to effectively control the manganese sulphide particle characteristics in the absence of a micromixing device.

Due to short precipitation times and 1:1 reaction molar ratio, the resultant particle size distribution is sensitive to the addition rate of the reagents—hence, a slightly unequal pumping rate could cause variations in the quantity of either $MnSO_4$ or Na_2S reagent to enter the agitation vessel; this

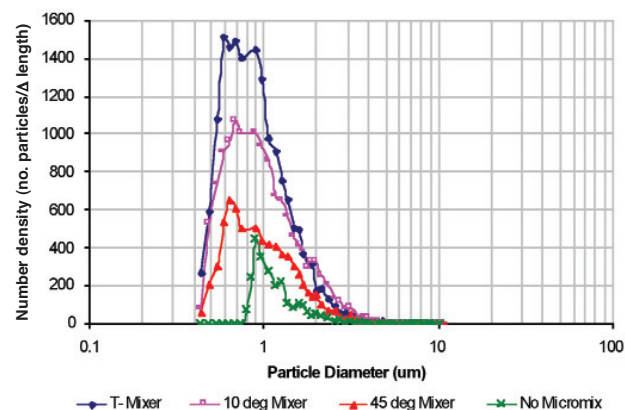

Figure 3—Manganese sulphide particle size distribution per 1 ml sample using different mixing devices for a reagent concentration of 0.007 M

| Experiment number | Objective | Method | Conditions |
|-------------------|--|--|---|
| B1 | Determine the MnS PSD and behaviour | Parallel reagent addition into an agitated vessel | $[MnSO_4] = 0.007 M$ $[Na_2S] = 0.007 M$ |
| B2, B3 and B4 | Determine the MnS PSD and behaviour | Reagent addition and pinpoint mixing using a T, 10° and 45° mixer respectively | $[MnSO_4] = 0.007 M$ $[Na_2S] = 0.007 M$ |
| C1, C2 and C3 | Effect of change in MnS PSD coefficient of variance using direct product addition into agitated vessel after reagent micromixing | Direct reagent addition using T, 10° and 45° mixing devices respectively | $[MnSO_4] = 0.007 M$ $[Na_2S] = 0.007 M$ |

Investigating the control of manganese sulphide precipitation

would result in the molar ratio of mixing not being exactly 1:1 thereby causing some unreacted reagent to flow continuously into the reactor where further precipitation commences under different conditions. This may have been the cause for the characteristic long tail towards the right side of the size distribution for all the micromixing experiments (see Figure 3).

The results obtained from experiments involving the T-mixer indicated the generation of a greater number of MnS particles which were smaller in size (see Figure 3 and Figure 7). As expected, tests conducted using the T-mixer resulted in a narrower particle size distribution when compared to the one using parallel reagent addition directly into the agitation vessel (see Figure 4). This points to the presence of primary particle control being present in the system. Since both reagents (MnSO_4 and Na_2S) were rapidly mixed in the T- and Y-mixers, the fluctuations in supersaturation were minimized thus resulting in a narrower particle size distribution as indicated by the coefficient of variance. The smaller mean particle size was due to spontaneous homogeneous nucleation.

In comparing the 3 mixing devices, the largest numbers of particles were generated using the T-mixer, followed by the 10° and the 45° Y-mixers respectively. This can be attributed to the difference in the degree of micromixing within each of the mixers as a result of, firstly, the mixers being constructed with a very narrow feed pipe diameters (1.5 mm) causing an increase in fluid flow velocity of both reagents. Secondly, the angle of collision also has a significant effect on the micromixing process, such that for the T-mixer, a direct collision of the two reagents at a high velocity generates the most force and turbulence at the point of mixing; whereas for the 2 Y-mixers, the respective linear velocities will be lower due to angular collision.

In cases where only nucleation occurs, the mean particle size will decrease due to formation of new nuclei. During the experiment involving the T-mixer, it was found that there were increases in the number of particles and the mean particle size with time, which was indicative of simultaneous nucleation and aggregation. When comparisons were made between Figure 7 and Figure 8 with particular interest in the T-mixer, it was found that the simultaneous nucleation and aggregation of particles occur in the first 20 minutes. In the period between 20 and 30 minutes, nucleation was replaced by particle breakage in the presence of aggregation, which

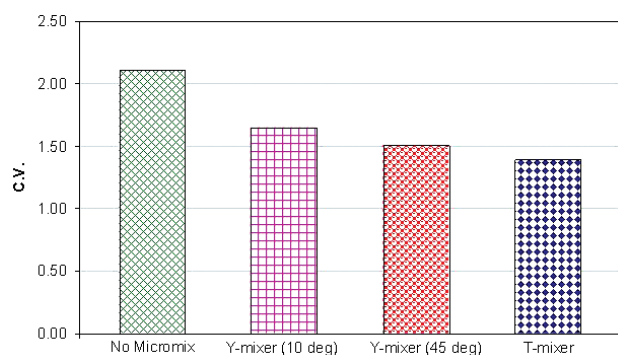

Figure 4—Coefficient of variance for size distributions using different mixing devices for reagent concentration of 0.007 M

dominated the last 10 minutes of sampling. Under ideal mixing conditions without particle breakage, this phenomenon would not have been observed due to the rapid precipitation of manganese sulphide resulting from the rapid consumption of supersaturation upon mixing, making further nucleation and crystal growth negligible.

For the experiment involving the 10° Y-mixer, it was found that the mean particle size increases with time and the number of particles also increases with time. However, the

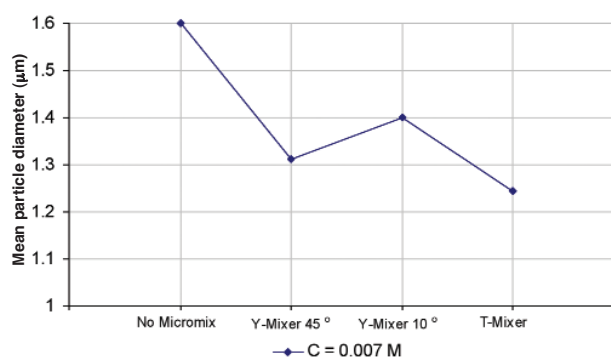

Figure 5—Mean particle size for different mixers per 1 ml sample after a residence time of 40 minutes in the reactor for a reagent concentration of 0.007 M

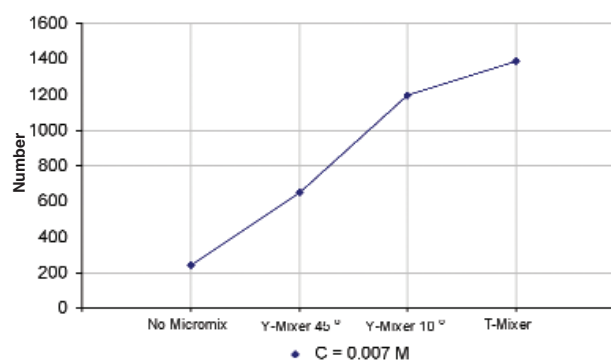

Figure 6—Particle number of different mixers per 1 ml sample after a residence time of 40 minutes in the reactor for a reagent concentration of 0.007 M

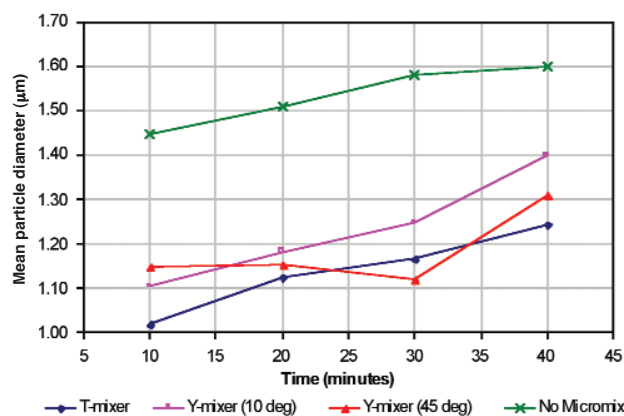

Figure 7—Change in mean particle size with time per 1 ml sample using different mixing devices for a reagent concentration of 0.007 M

Investigating the control of manganese sulphide precipitation

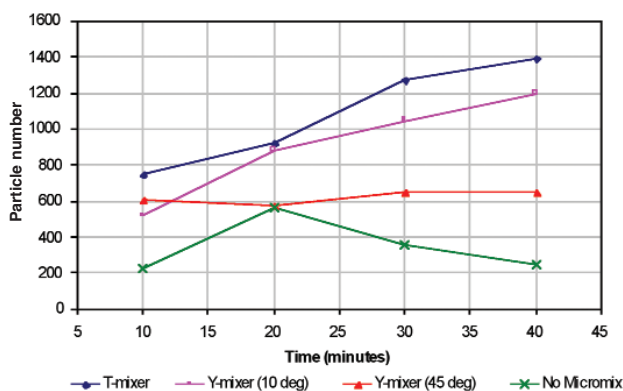

Figure 8—Change in particle number with time per 1 ml sample using different mixing devices for a reagent concentration of 0.007 M

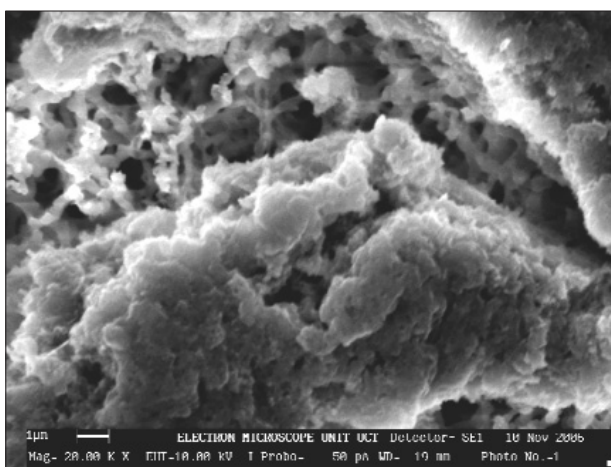

Figure 9—T-mixer sample from experiment B2 (0.007 M after 40 minutes)

rate at which the particle number increased decreased after 20 minutes, and the rate of size enlargement increased after 30 minutes. This may be evidence of nucleation (where it ceases between 20 and 30 minutes similar to the T-mixer experiment) accompanied by aggregation of particles throughout the entire sampling period.

For the experiment involving the 45° Y-mixer, it was found that some particle aggregation was present in the first 20 minutes followed by nucleation between 20 and 30 minutes. (The solid volumetric hold-up increased from $8.14 \times 10^{-4} \text{ m}^3$ to $8.50 \times 10^{-4} \text{ m}^3$ between 20 and 30 minutes.) The fact that the graph (Figure 7) indicated crystal growth during the last 10 minutes of the experiment still requires further investigation before any conclusions can be drawn.

Furthermore, such an indication might have been an experimental or analytical error since crystal growth is negligible for sparingly soluble systems.

From the pictures of the samples taken (Figures 9–12) under the scanning electron microscope (SEM), it can be seen that aggregation of the sulphide particles is the dominating mechanism for all the micromixing experiments. The main difference between the various the micromixing experiments being that the particles within the aggregates appear to be smaller in size than the one shown in Figure 12 and as indicated graphically in Figure 7.

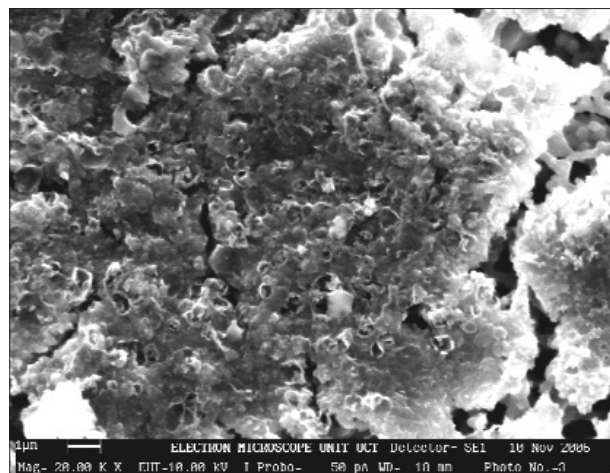

Figure 10—Y-mixer (10 deg) sample from experiment B3 (0.007 M after 40 minutes)

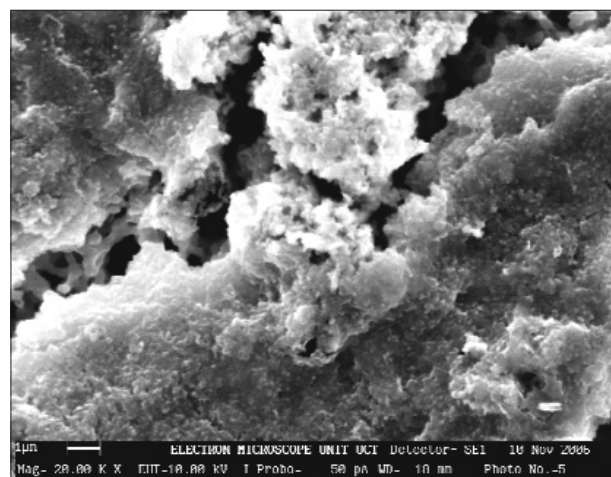

Figure 11—Y-mixer (45 deg) sample from experiment B4 (0.007 M after 40 minutes)

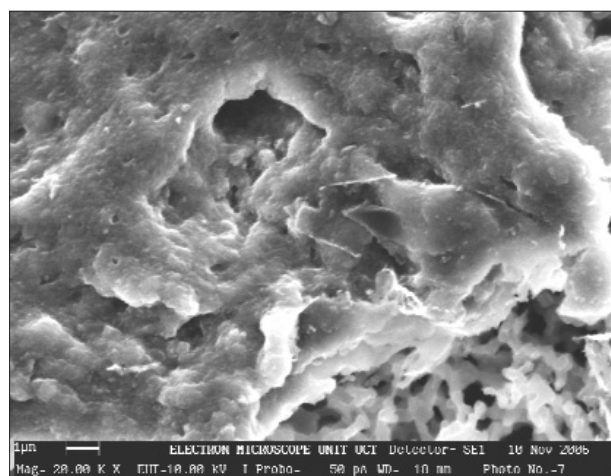

Figure 12—No micromixing sample from experiment B1 (0.007 M after 40 minutes)

Investigating the control of manganese sulphide precipitation

Direct addition experiments were conducted in the absence of the narrow product pipe which connects the mixing device to the agitation vessel. The results obtained indicated generation of fewer particles, which were also much larger in size when compared to the ones from the micromixing experiments.

The above phenomenon sheds some light on the reasons for the formation of smaller particles in micromixing experiments and larger ones through direct reagent. If nucleation is indeed incomplete at the immediate exit of the mixing device, direct addition into the agitation vessel will result in additional particle formation under the mixing environment. Further investigations are still required to understand the possible mechanism involved in the precipitation behaviour during direct addition.

The effect of increased residence times in the mixers on product characteristics can be investigated by connecting a long narrow pipe to the exit of the mixing device before being fed into the agitated vessel. This would allow for the crystallization to reach completion in the extension pipe, for which the diameter is small enough to allow high stream velocity, which promotes turbulent mixing and minimize supersaturation fluctuations.

Conclusion

The controlled generation of manganese sulphide particles size and distribution was investigated using various mixing configurations.

The precipitation without micromixing was found to have the least control over the precipitation compared to the micromixing experiments. This was due to a large difference in the local and global supersaturation within the reactor. The intensity of the mixing within the reactor is also not uniform and hence fluctuations in concentration and supersaturation results in different rates of nucleation, which produces a large range of particles. Also, as the distribution of the reagents is dependent on the intensity of the mixing, the control of the precipitation is not good since the nucleation rate is much greater than the circulation rate within the reactor.

The width of the manganese sulphide particle size distribution can be narrowed by promoting primary particle control through rapid micromixing under a high supersaturation conditions using micromixers. Under dilute reagent concentrations, the T-mixer was found to be the most effective in generating small particles in the 1 μm range with a narrow size distribution.

For all experiments, particle aggregation occurred throughout the entire sampling period with nucleation ceasing after 30 minutes with agglomeration dominating the last 10 minutes.

The results obtained from direct addition indicated a general increase in mean particle size and decrease in total particle number. This phenomenon may be due to incomplete crystallization at the immediate exit of the mixing device and further investigations need to be conducted before drawing conclusions about the possible mechanisms governing the precipitation process during direct addition.

Nomenclature

| | |
|----------|--|
| CV | Coefficient of variance |
| d_p | Particle diameter in m |
| g | Gravitational acceleration in m.s^{-2} |
| L | Particle dimension parameter |
| m_j | jth moment of particle size distribution m |
| M | Solution molarity in mol.dm^{-3} |
| N_{js} | Just suspended impeller speed in rpm |
| ρ_s | Solid density in kg.m^{-3} |
| ρ_L | Liquid density in kg.m^{-3} |
| S | Non-dimensional parameter in solid-liquid suspension |
| ν | Kinematic viscosity in m.s^{-1} |
| X | Solid to liquid volume ratio |

References

- LEWIS, A.E. and VAN HILLE, R. *An exploration into sulphide precipitation method and its effects on metal sulphide removal*, University of Cape Town, South Africa, Elsevier, 2005. pp. 197–203.
- Bryson, A.W. and Bijsterveld, C.H. *Kinetics of the precipitation of manganese and cobalt sulphides in the purification of the manganese sulphate electrolyte*, University of the Witwatersrand, Johannesburg, South Africa, Elsevier, 1990. pp. 75–83.
- NAGATA, S. *Mixing Principles and Application*, Halsted Press, New York, 1975. pp. 186–194.
- MYERSON, A.S. *Handbook of Industrial Crystallisation*, Second Edition, Butterworth Heinemann, Boston, 2002. chapters 2, 3, and 6.
- TORBACKE, M. and RASMUSON, A.C. Influence of different scales of mixing in reaction crystallization, Department of Chemical Engineering and Technology, Royal Institute of Technology, Stockholm, Sweden, *Chemical Engineering Science*, Pergamom, 2001. pp. 2459–2473.
- BLANDIN, A.F., MANGIN, D., NALLET, V., KLEIN, J.P. and BOSSOUTROT, J.M. Kinetics identification of salicylic acid precipitation through experiments in a batch stirred vessel and a T-mixer, *Chemical Engineering Journal* 81, Elsevier Science, 2001. pp. 91–100.
- GRADL, J., SCHWARZER, H., SCHWERTFIRM, F., MANHART, M.L., and PEUKERT, W. Precipitation of nanoparticles in a T-mixer: Coupling the particle population dynamics with hydrodynamics through direct numerical simulation, Institute of Particle Technology, University of Erlangen-Nurnberg, Germany, *Chemical Engineering and Processing*, Elsevier, 2006. pp. 908–916.
- GARSDIE, J. and TAVARE, N.S. *Chem. Eng. Science*, vol. 40, 1985. pp. 1485–1493.
- POHORECKI, R. and BALDYGA, J. *Industrial Crystallisation 1978* Jong, E.J. and Jancic S.J., (eds.) North Holland, Amsterdam, 1979. pp. 249–259.
- POHORECKI, R. and BALDYGA, J. *Chemical Engineering Science*, vol. 38, 1983. pp. 79–83.
- POHORECKI, R. and BALDYGA, J. *Chemical Engineering Science*, vol. 43, 1988. pp. 1949–1954.
- HINZE, J.O. *Turbulence*, 2nd Edition, McGraw-Hille, New York. 1975.
- ARMENANTE, P.M. et al. *Encyclopaedia of Chemical Processing: Multiphase Mixing and Solid-Liquid Mixing in Agitated Reactors*, 2006. vol. 3, Taylor and Francis Group, New York, London, pp. 1767–1777.
- RANDOLPH, A.D. and LARSON, M.A. *Theory of Particulate Process: Analysis and Technique of Continuous Crystallization*, Academic Press, New York, London, 1971. pp. 30. ◆